



## The High-Speed Frequency Counter— A New Solution to Old Problems

**A**CCURATE frequency measurements have always been somewhat troublesome. To make such measurements, the state of the art has required the use of three separate equipments—a frequency standard, an interpolating system, and a detector. A thing to be hoped for was a new device that would automatically measure the frequency of an unknown with the same accuracy obtained with existing methods.

The -hp- Model 524A Frequency Counter is a new type of measuring instrument that performs this very function. The instrument directly measures and directly displays the frequency of an unknown. The unknown can lie anywhere within the range from 0.01 cps to 10 megacycles—a range that embraces the greater part of all frequency-measuring work.

The simplicity of operation of the frequency counter is worthy of special mention: when an unknown is connected to the input terminals, the measured frequency is displayed automatically by the arrangement

shown in Figure 1. A decimal multiplier panel switch modifies the displayed value when the measurements have been made for less or more than one second.

The Model 524A is based on pulse techniques and makes two types of measurements relating to frequency. First, the instrument counts unknown frequencies for a short accurately-known time interval of 10, 1, 0.1, 0.01, or 0.001 second as desired. The instrument first counts and then displays the count, repeating this process as long as desired. Second, the instrument measures period—the time consumed by one cycle of a voltage. Periods are counted in units of 1 microsecond up to a maximum of 100 seconds. Periods also are first measured and then displayed in a repeating process.

The accuracy of the -hp- Model 524A Frequency Counter is determined by a gating circuit that is accurate within 0.1 microsecond and by an internal crystal oscillator that is accurate within approximately 2 parts per million per week. Accuracy is thus determined primarily by the oscillator, which is equal in quality to a high-quality secondary frequency standard. For this reason, the -hp- Model 524A Frequency Counter is regarded as a new type of secondary frequency standard that has the advantages of displaying the measured frequency directly and of measuring frequencies as high as 10 megacycles. Where there is at hand a laboratory standard of better accuracy than that of the internal oscillator, the accuracy of the Model 524A can be increased by substituting the laboratory standard for the internal oscillator. A panel connector and switch are provided for this purpose.

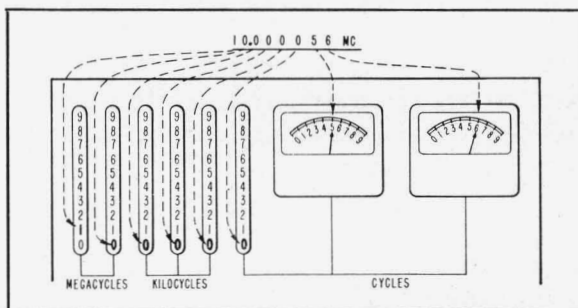

Figure 1. Display arrangement of new -hp- Model 524A Frequency Counter. Columns of neon tubes behind panel slots illuminate the proper numerals which are reverse-printed on transparent plastic. Example shown represents a frequency of 10,000,056 cps counted for period of one second. Maximum rate for instrument is 10 mc; maximum counting period is 10 seconds.

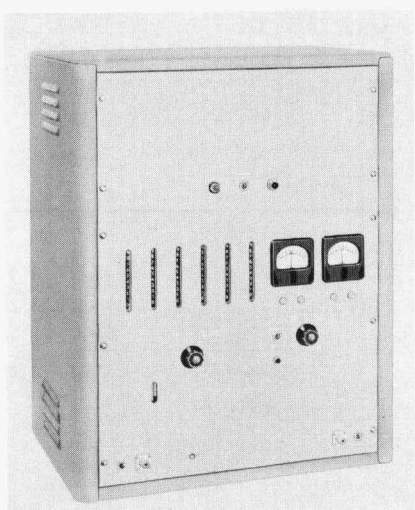

Figure 2. New -hp- Model 524A Frequency Counter.

A frequency counter having a range as wide as 10 megacycles is a powerful laboratory and production tool. Besides being a secondary frequency standard for the laboratory, the frequency counter can be used to calibrate oscillators, measure frequency drift, period, and for production applications involving calibrating and tuning. When used with a light source and phototube such as the -hp- Model 506A, the frequency counter can be used to measure precisely the speed of rotation of high-speed devices such as small motors and centrifuges.

#### CIRCUIT DESCRIPTION

For introductory purposes, the circuit of the Model 524A can be represented by the block diagram of Figure 3. Here, the unknown frequency is applied through a wide-band squaring amplifier to a fast gate controlled by a time base generator. When the fast gate is open, the unknown is applied to the counting circuits; when the fast gate closes, the counting circuits display the counted frequency until the time base generator triggers the resetting circuit. The counting circuits are then reset to zero and the gate is again opened so that the next sample of the unknown can be counted.

The heart and distinguishing feature of the Model 524A is its high-

speed counting circuit, a development of the high-speed scaler described here in a recent issue<sup>1</sup>. For reliable 10-megacycle operation, the requirements of the circuit are that it must have a double-pulse resolving time of 0.1 microsecond and a triple-pulse resolving time of 0.2 microsecond, as well as being capable of continuous 10-megacycle operation. The filling of these requirements by the scaler described before has allowed the design of the Model 524A as a high-speed frequency counter.

The complete counting circuit consists of eight cascaded scalers with indicating systems. All scalers are decade types that generate one output pulse for every ten pulses received by the circuit. The input scaler is the high-speed 10-megacycle circuit that divides the incoming pulses by decades and indicates any remaining counts on a panel meter. The second circuit is similar to the first, except for slower speed operation. The remaining six scalers each indicate on a neon lamp the last digit of the quantity of pulses received from the preceding scaler.

#### TIME BASE GENERATOR

The circuit that determines the time of opening and closing of the fast gate is the time base generator. This circuit includes a 100 kc precision crystal-controlled oscillator and a series of precision frequency dividers that provide the following time bases or sampling times:

0.001 Second	1.000 Second
0.010 Second	10.00 Seconds
0.100 Second	

The longest sampling time of 10 seconds combined with the highest counting rate of 10 megacycles per second determine the maximum count that can be made by the instrument. The product of sampling time and maximum rate gives a total capacity for the instrument of one

<sup>1</sup>A. S. Bagley, *A 10 MC Scaler for Nuclear Counting and Frequency Measurement*, Hewlett-Packard Journal, Vol. 2, No. 2, October, 1950.

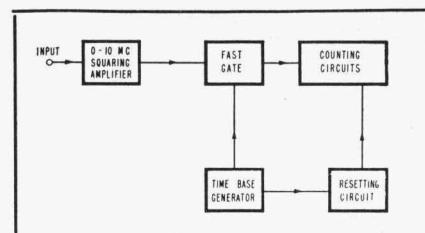

Figure 3. Basic block diagram of -hp- Model 524A Frequency Counter.

hundred million counts, which in practice is limited to 99,999,999 counts because of the eight-place indicating system.

The length of time that counts are displayed is designed to be equal in each instance to the sampling time. Display times that are less than 1 second are too short to permit the displayed data to be recorded in a notebook or data sheet, but these short display times have a practical value when performing operations such as tuning signal sources and oscillators. For such applications, the short sampling and display times cause the indicating system to give a continuous reading, thereby allowing immediate corrections to be made in the tuning operation.

#### PERIOD MEASUREMENTS

Besides being arranged to measure frequency directly, the Model 524A is also arranged so that it can count the frequency of its internal 100 kc precision oscillator for a time interval equal to 10 periods of an unknown frequency. Thus, the instrument counts in units of 10 microseconds for a length of time equal to 10 cycles of the unknown, thereby displaying the period of 1 cycle of the unknown in units of 1 microsecond. For example, an unknown of 1 cps would cause the instrument to count the frequency of the internal 100 kc oscillator for a period of 10 cycles, giving the period of 1 cycle of the unknown as one million microseconds.

The value of period measurements becomes apparent when measuring low frequencies, where on direct frequency measurements the available



sampling times would permit only a few cycles of the unknown to be measured. The ability to make period measurements extends the measurement range of the instrument to frequencies as low as 0.01 cps.

#### ACCURACY

Two factors influence accuracy: the reliability of the fast gate and the accuracy of the oscillator, whether the internal precision oscillator or an external frequency standard. The fast gate has been designed to open accurately within 0.1 microsecond. In counting terms, this reliability will give an accuracy of  $\pm 1$  count. In frequency terms, the gate reliability will give an accuracy of within  $\pm 0.1$  cycle if the sampling time is 10 seconds or within  $\pm 1$  cycle if the sampling time is 1 second. On shorter sampling times, the accuracy will be correspondingly less.

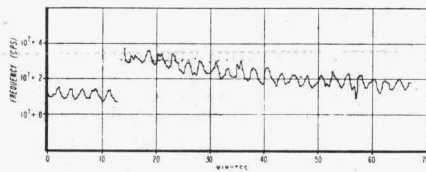

Figure 4. Measured stability curve of 10 mc oscillator turned off for one minute after 13 minutes.

Although the fast gate opens reliably within 0.1 microsecond, the signal to open the gate is given by the precision oscillator. The tolerance of the oscillator must therefore be added to the tolerance of the fast gate to obtain the overall accuracy for the instrument. Since the internal oscillator is accurate within approximately 2 parts per million per week, the Model 524A is basically accurate within 0.0005%  $\pm 1$  count. When the instrument is used with an external frequency standard, the accuracy of the measurement becomes the accuracy of the standard diminished by 1 count.

A visual indication of the counting capabilities of the Model 524A is shown by the curve in Figure 4. The curve was plotted from data taken while using a high-stability laboratory frequency standard in place of

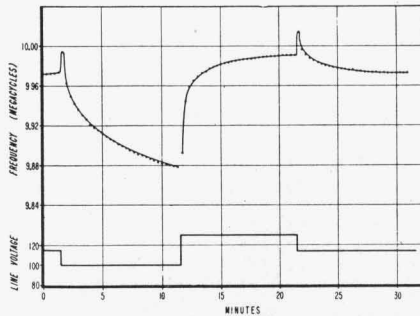

Figure 5(A)

Frequency shift in -hp Model 650A Test Oscillator operating at 10 mc when subjected to  $\pm 15$ -volt line change. Measurements made at 20-second intervals. Discontinuous curve results from sudden

the internal oscillator in the Model 524A and represents the type of measurement that can be made where high-precision standards are available. The source under measurement was a 10-megacycle oscillator whose crystal oven operation was investigated. The cyclic nature of the curve is caused by the cycling of the 10-megacycle crystal oven thermostat; the discontinuity resulted from turning off the oscillator for one minute.

Note that the ordinate of Figure 4 is tremendously expanded, the whole vertical scale representing only 4 parts in ten million. From the curve it is apparent that the measurements were made within 1 part in one hundred million.

#### MEASUREMENTS

As lower and lower frequencies are measured, the tolerance of  $\pm 1$  count becomes increasingly important on a percentage basis. Where a tolerance of 1 count in one hundred million is but 0.000001%, a tolerance of 1 count in one hundred thousand is 0.001%. Finally, a point is reached where measurements can be made with greater accuracy by reversing the frequency measurement process; that is, by determining frequency through a measurement of its period as described before. This transition point is illustrated in Figure 6, where curve A is a plot of theoretical accuracy obtainable on period measurements, and curve B a plot of accuracy

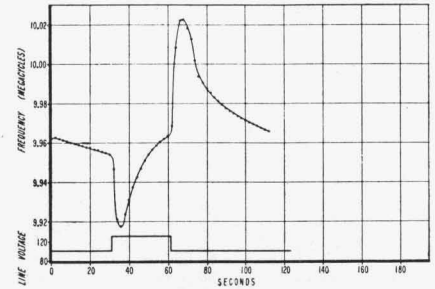

Figure 5(B)

change in frequency when line voltage is changed and is further investigated in Figure 5(b) where measurements are made at 2-second intervals to magnify discontinuous area. Such measurements are typical of those that can be made with Model 524A.

obtainable on 10-second frequency counts. Curve A shows that highest accuracy is obtained on period measurements when the unknown frequency is low. Conversely, curve B shows that highest accuracy is obtained on direct frequency measurements when the unknown frequency is high. A transition point occurs at 316 cps where, to obtain best accuracy, the method of measurement must be changed from a direct measurement of frequency to a measurement of period.

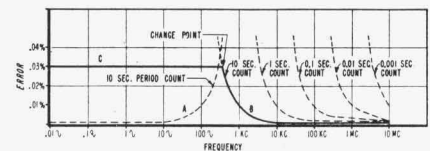

Figure 6. Accuracy curve of Model 524A Frequency Counter for direct frequency and period measurements.

Curve A in Figure 6 is a theoretical curve and its most accurate region can not be attained in actual practice because the rate-of-rise of low-frequency voltages is too slow to permit accurate triggering. However, for period measurements, it has been established that the accuracy of the Model 524A is within 0.03% on frequencies from 316 cps to as low as 0.01 cps.

#### COMPLETE CIRCUIT

The complete circuit of the Model 524A is represented by the block diagram of Figure 8. On direct frequency measurements, the unknown is applied through the input squaring

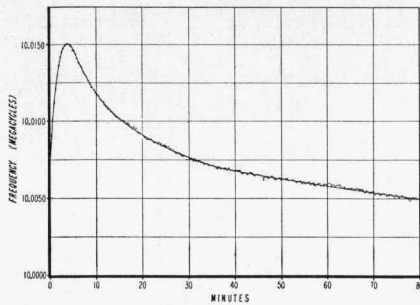

Figure 7. Warm-up stability curve of -hp- Model 608A 10-500 mc signal generator with frequency dial set for 10-megacycle output. Measurements made with -hp- Model 524A at 20-second intervals.

amplifier and fast gate to the counting circuits as described before. Depending upon the position of the multiplier switch in the time base circuits, a time base lying between 0.0001 second and 1 second is applied through the input switch to the amplitude discriminator. The amplitude discriminator is basically a regenerative amplifier designed for rapid rise of regenerative voltage once the driving voltage has reached a critical value. The circuit thus adds to the reliability of the instrument by insuring that triggering will always occur at the same point of the time base. The degree of discrimination of the circuit is sufficient to give a reliability of within 0.03% on time bases as long as 10 seconds.

Following the amplitude discriminator is a decade scaler that divides by a factor of ten the time bases generated by the time base circuits. The decade scaler operates into a gate that is always open on automatic measurements so that the output of the scaler is applied both to the gate for the resetting circuit and to the delay multivibrator that feeds into the fast bistable multivibrator.

The function of the fast bistable multivibrator is to open and close both the fast gate and the gate to the resetting circuit. The multivibrator is arranged so that when one gate is open the other is always closed. A high order of reliability is evident in the fact that opening or closing time combined with any jitter are such

that the fast gate is reliable within 0.1 microsecond.

The operation of the gating circuitry is as follows: when a pulse comes from the decade scaler and passes through the first gate, it is applied both to the delay multivibrator and to the gate for

the resetting circuit. If the gate is open, the pulse triggers the resetting circuits, clearing the counters and resetting them to zero.

Meantime, the pulse has triggered the delay multivibrator which delays the triggering of the fast bistable multivibrator by a fixed interval of 100 microseconds. The delay multivibrator also is carefully designed to achieve reliability. To insure an accurate delay interval, a 10 kc voltage from the time base circuits is superimposed upon the grid of the delay multivibrator in such a way that the delay multivibrator operates with the precision of the time base.

At the end of 100 microseconds, the delay multivibrator causes the fast bistable multivibrator to switch, opening the fast gate and closing the resetting gate. Since the counting circuits have been cleared and reset to zero, they are ready to count the unknown admitted through the fast gate.

The next pulse from the decade scaler finds the resetting gate closed, but triggers the delay multivibrator. After the fixed delay of 100 microseconds, the delay multivibrator operates through the fast bistable multivibrator to open the resetting gate and to close the fast gate. The counting circuits then display the counted value until the next pulse from the decade scaler causes the whole process to repeat.

The operation of the instrument on period measurements is similar to that on direct frequency measure-

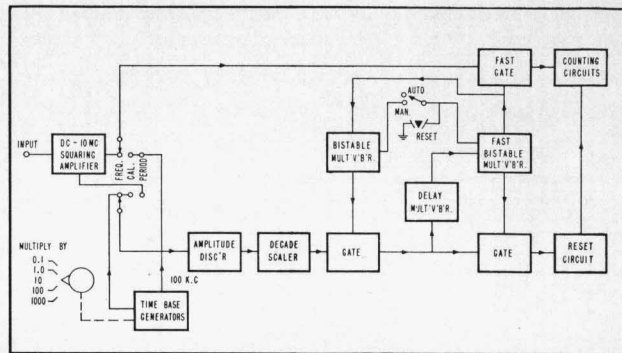

Figure 8. Block diagram of -hp- Model 524A Frequency Counter.

ments, except that the input switch is arranged so that the 100 kc frequency from the time base circuits is applied to the counters and 10 cycles of the unknown are used as the time base.

A third position of the input switch allows the operation of the overall circuit to be checked, using the 100 kc frequency from the time base circuits as the unknown.

-A. S. Bagley

#### SPECIFICATIONS FOR MODEL 524A FREQUENCY COUNTER

**MAXIMUM COUNTING RATE:** Ten million cycles per second.

**PRESENTATION:** Total indication, 8 places. First six places on neon lamp banks. Last two places on two meters.

**PERIOD OF COUNT:** 0.001, 0.01, 0.1, 1, and 10 seconds, selected by panel control. Counting and display periods are equal and are automatically cycled. Panel push button allows counting for a single period with continuous display of count until push button again depressed.

**LOW FREQUENCIES:** Instrument can be switched so that low frequencies will operate as time bases. Period of low frequencies is displayed in microseconds.

**ACCURACY:** Direct frequency measurement:  $\pm 1$  count  $\pm$  tolerance of oscillator. Internal 100 kc crystal oscillator tolerance is 2 parts per million per week. External laboratory standards can be used to obtain higher oscillator accuracy.

**PERIOD MEASUREMENT:** Within 0.03% for frequencies up to 300 cps; within 1 microsecond for frequencies between 300 cps and 10 kc.

**INPUT TO COUNTING CIRCUIT:** Minimum required voltage is 1 volt peak.

**INPUT IMPEDANCE:** Approx. 100,000 ohms shunted by 30 mmf.

**100 KC TIMING CIRCUIT:** To use external 100 kc source requires 1 volt across 50,000 ohms shunted by 30 mmf.

**POWER SOURCE:** Operates from nominal 115-volt, 50/60 cycle supply. Requires approximately 400 watts.

**CABLES SUPPLIED:** 7' 6" power cord; permanently attached.

**CONNECTORS:** Signal and external standard connectors, BNC type jacks.

**MOUNTING:** Supplied in metal cabinet.

**SIZE:** Approx. 28" high, 21 $\frac{3}{4}$ " wide, 14" deep.

**WEIGHT:** Approx. 115 lbs. Shipping weight, approx. 175 lbs.

Price and delivery upon request. Data subject to change without notice.